

Play Area 1 in public open space - 479M2

Play structure - 0-21629-703 or similar & approved. Supplied by Kaiser & Kuhne

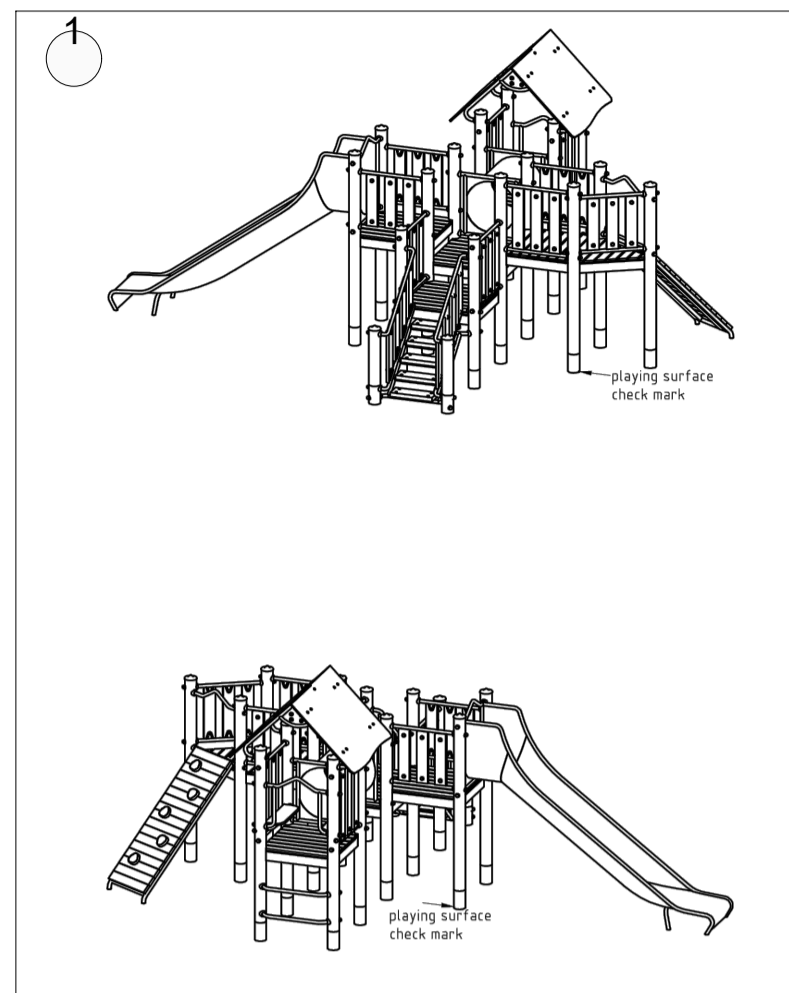

Combi climber on tube pedestals - 0-55480-703 or similar & approved. Supplied by Kaiser & Kuhne

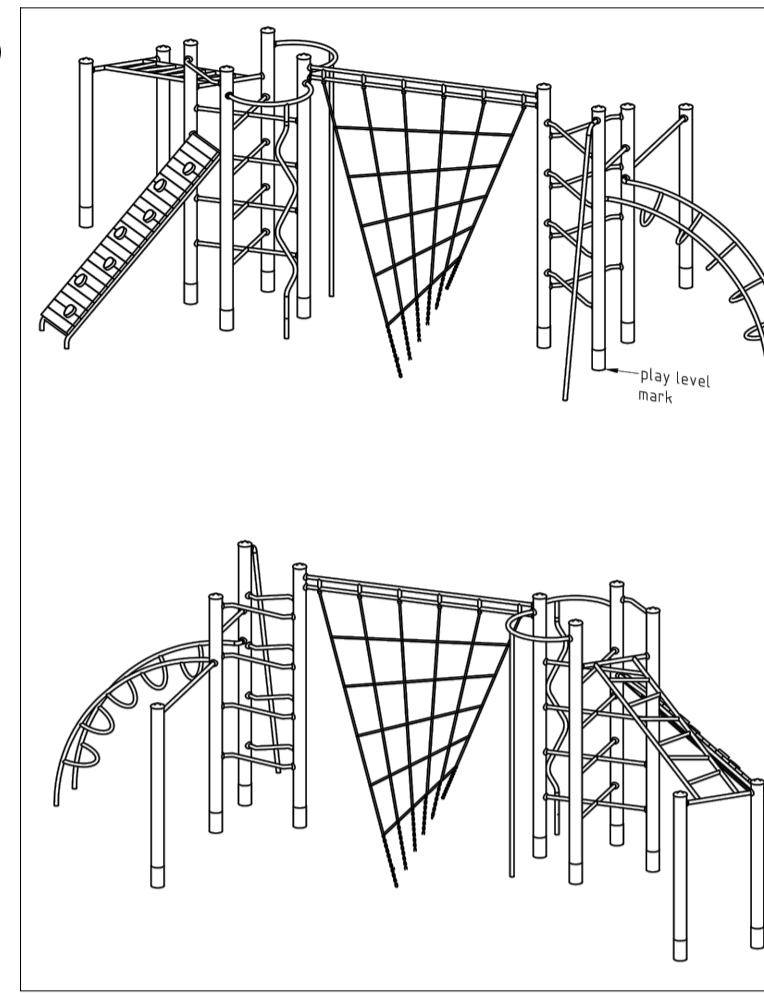

Play Area 2 in public open space - 174M2

Balance jump-over mushroom - square Dance, Product ref: 5553095; supplied by Eibe play or similar and approved.

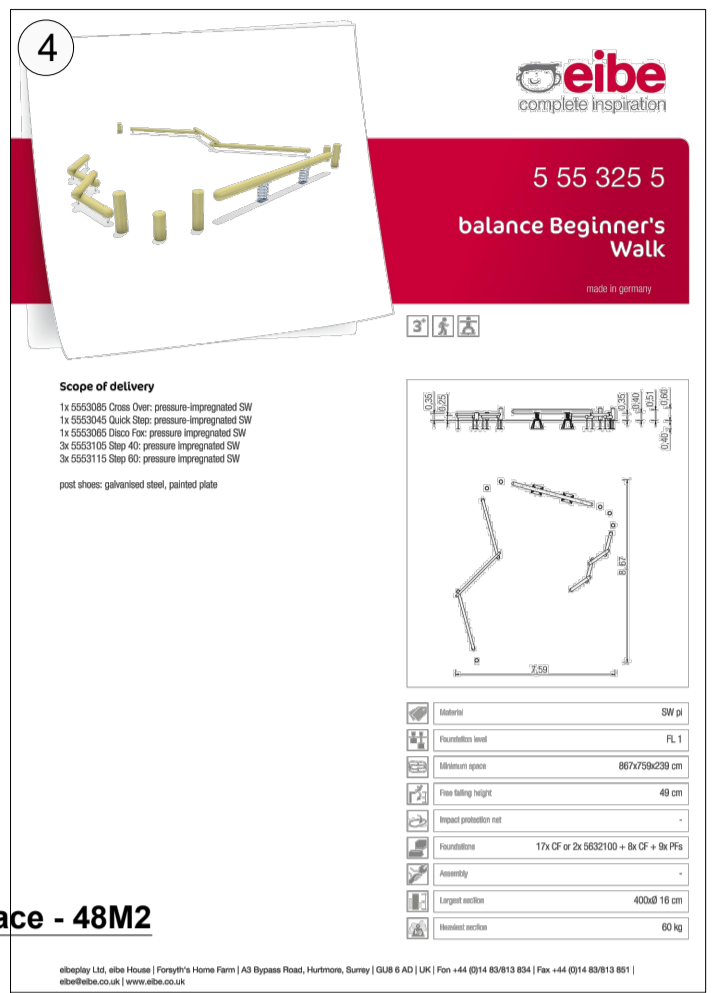
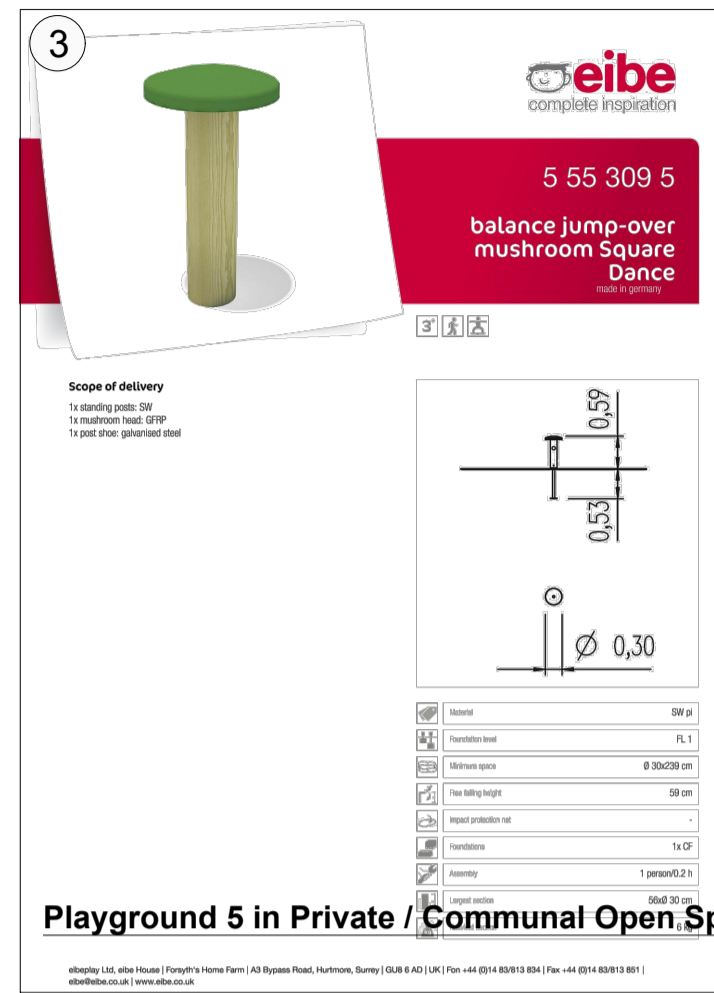

Play Area 3 - (Under 6yrs) in Private / Communal Open Space - 136M2

Unimini Apista, Product ref: 8047371; supplied by Hags playground equipment or similar and approved.

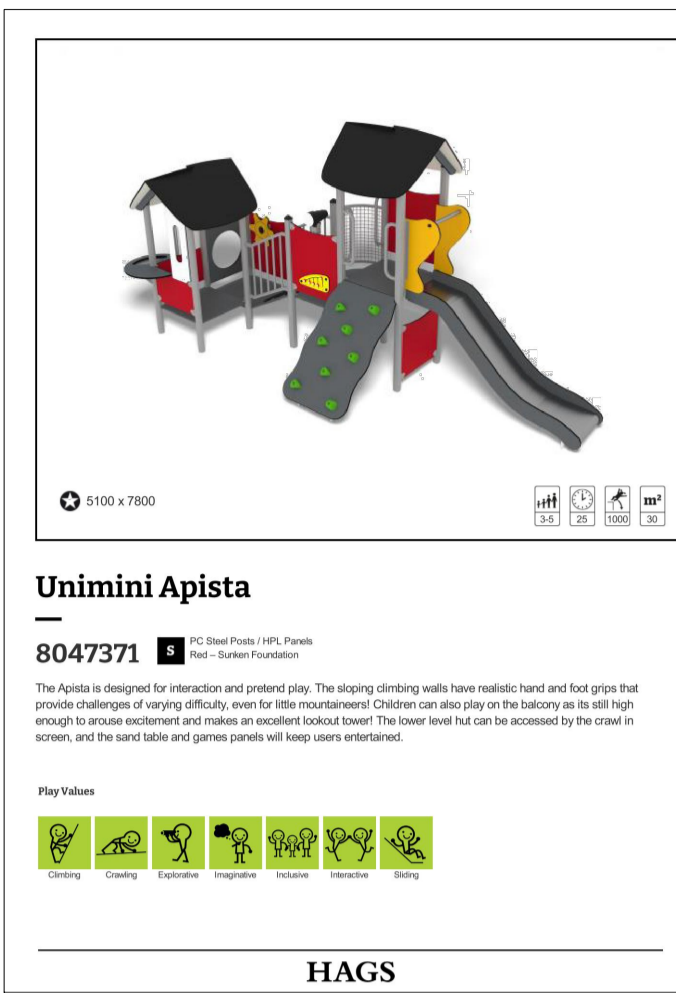

Spring Toy Turtle, Product ref: 8049865; supplied by Hags playground equipment or similar and approved.

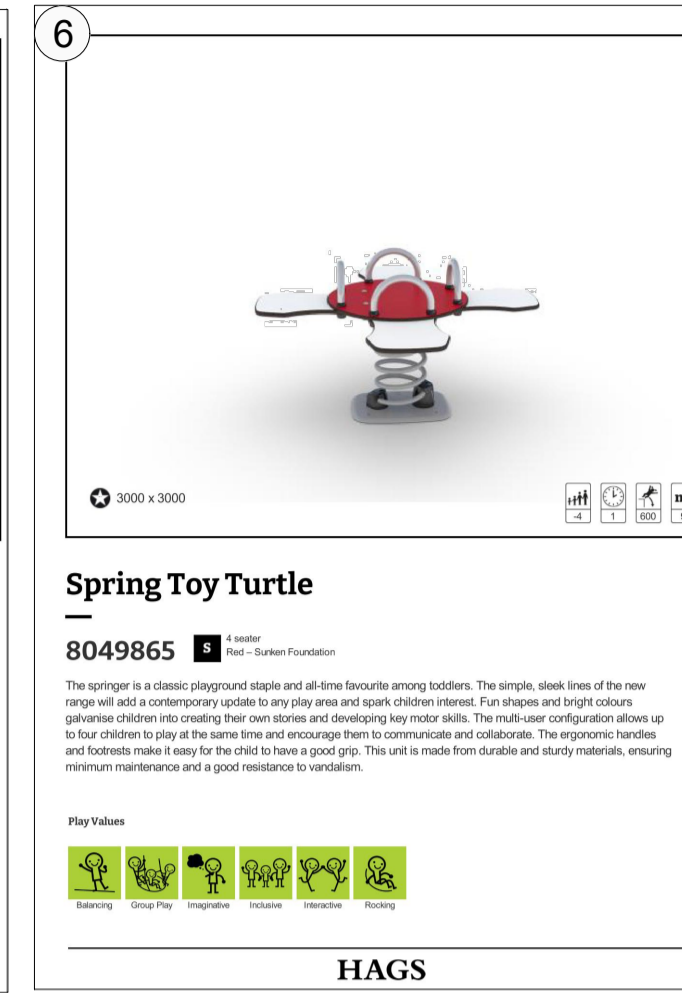

Swingo, Product ref: 8067041; supplied by Hags playground equipment or similar and approved.

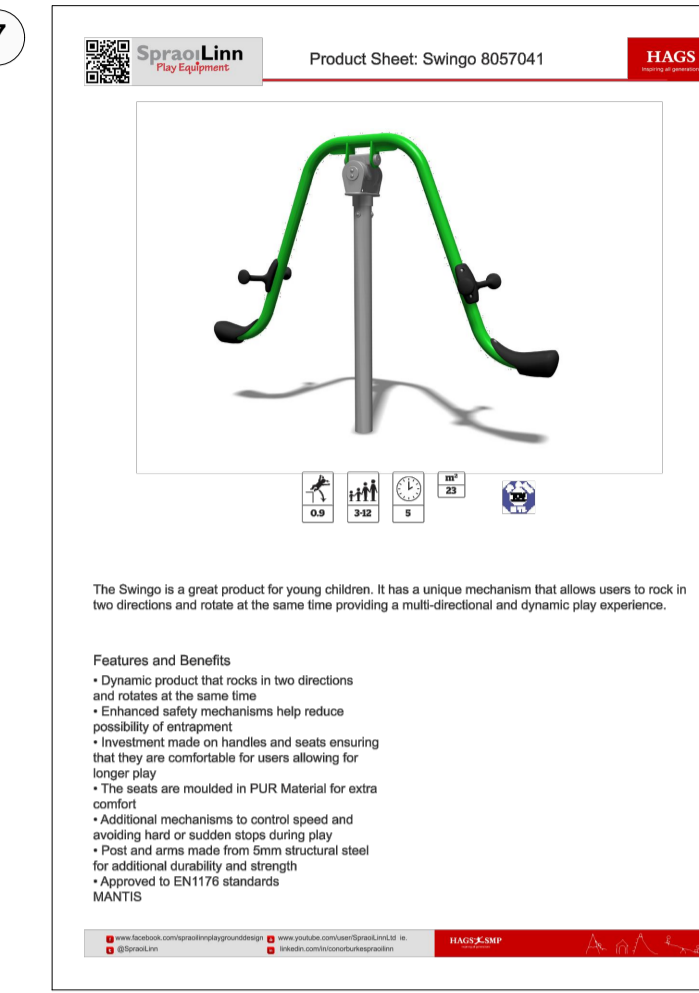

Ecorino Play Unit, Product ref: 51150474100; supplied by Eibe or similar and approved.

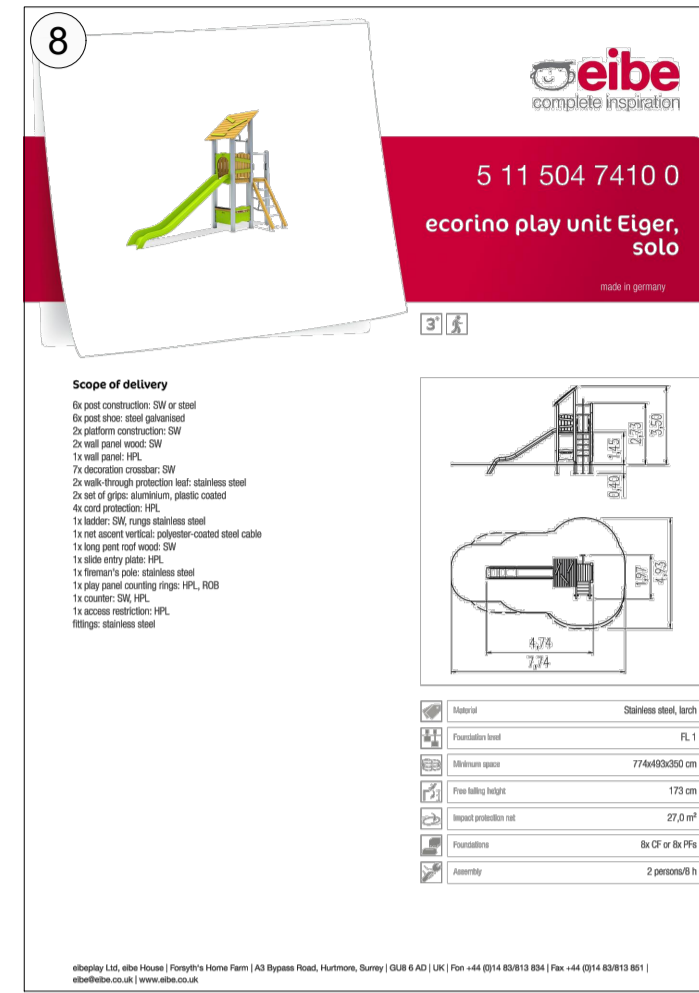

Play Area 4 in Private/Communal Open Space - 101M2

Active trail combination, Product ref: 52504007100; supplied by Eibe play or similar and approved.

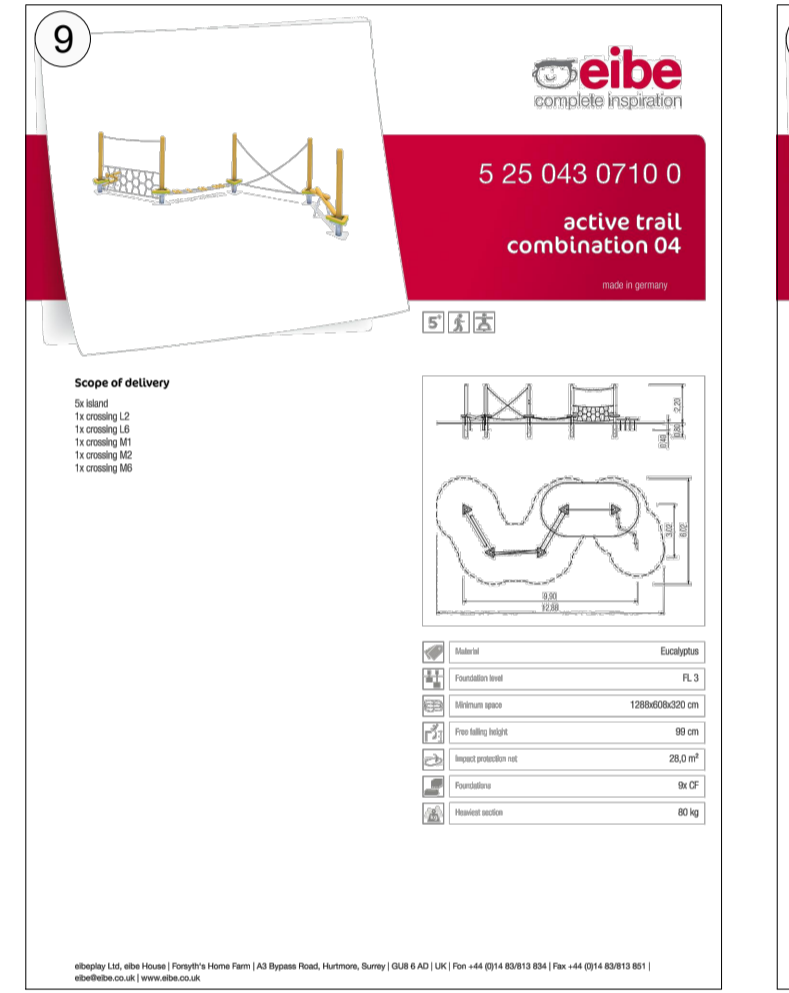

Paradiso Spring Rocker Mouse Product ref: 54535706300; supplied by Eibe play or similar and approved.

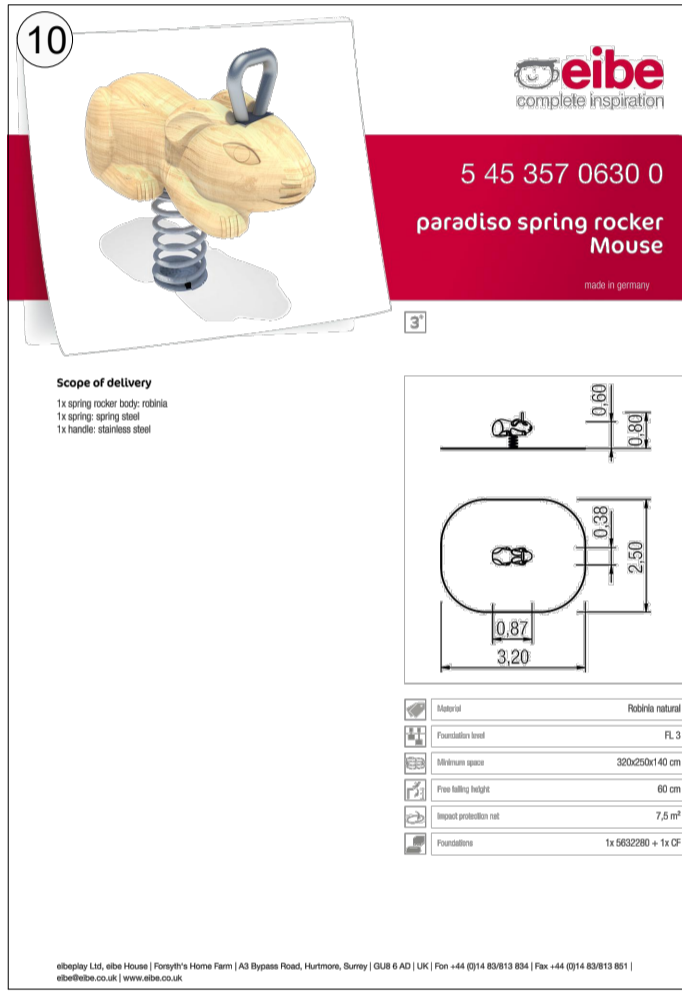

Play Area 5 in Private/Communal Open Space - 48M2

Playo Play unit Lisa Product ref: 51100101110; supplied by Eibe play or similar and approved.

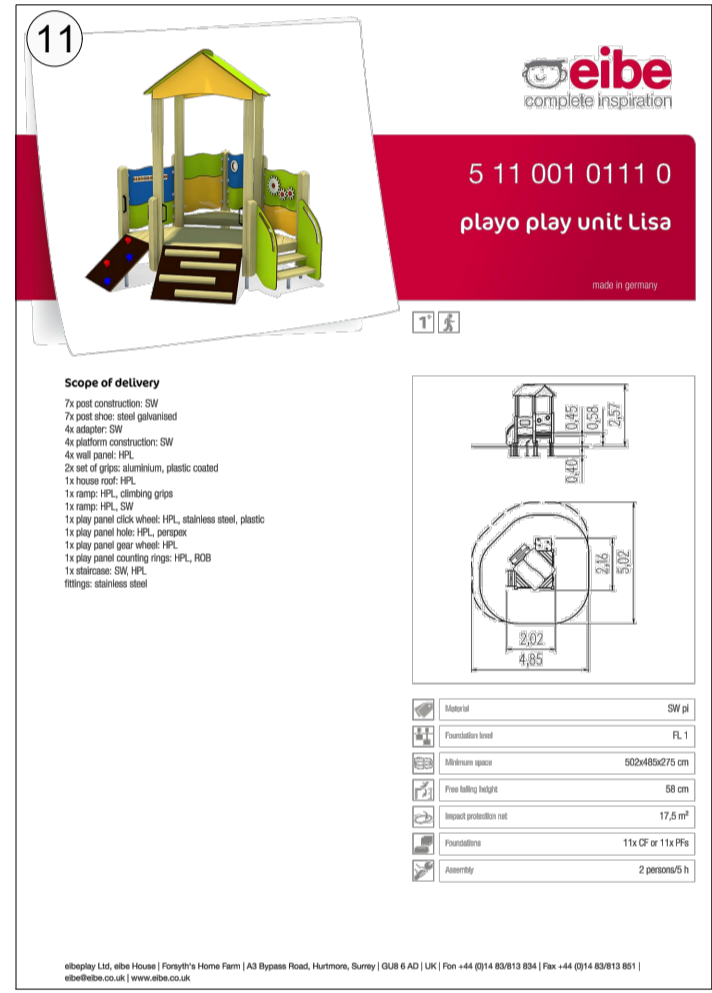

Minimondo Playunit Carnation Product ref: 55982401100; supplied by Eibe play or similar and approved.

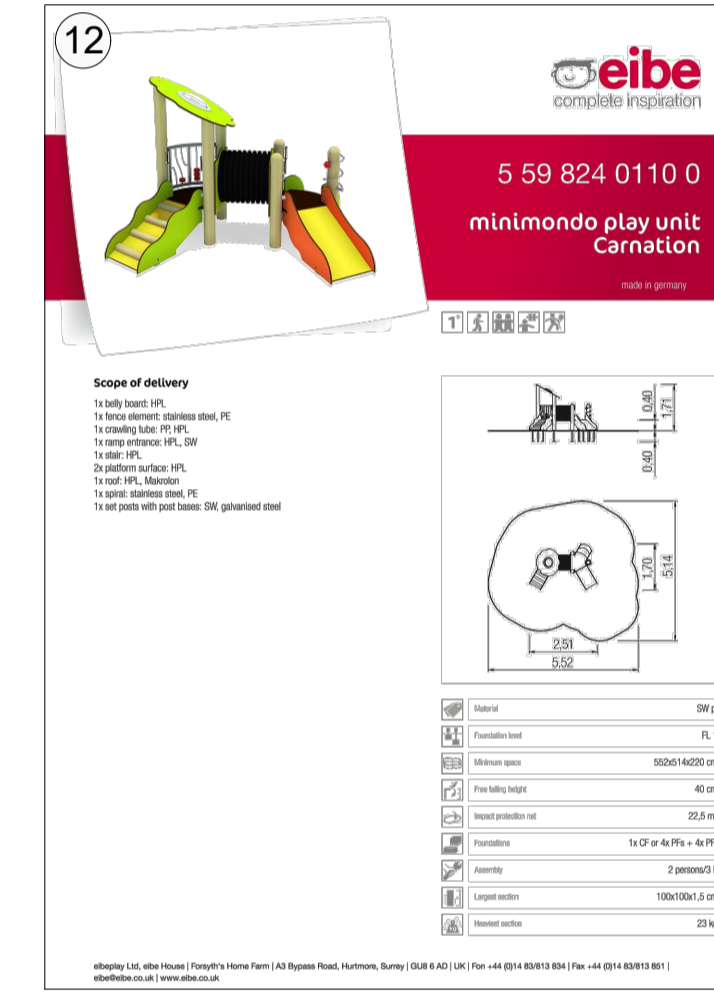

Play Area 6 in Public Open Space - 300M2

Paradiso balance station unit, Product ref: 54524106300; supplied by Eibe play or similar and approved.

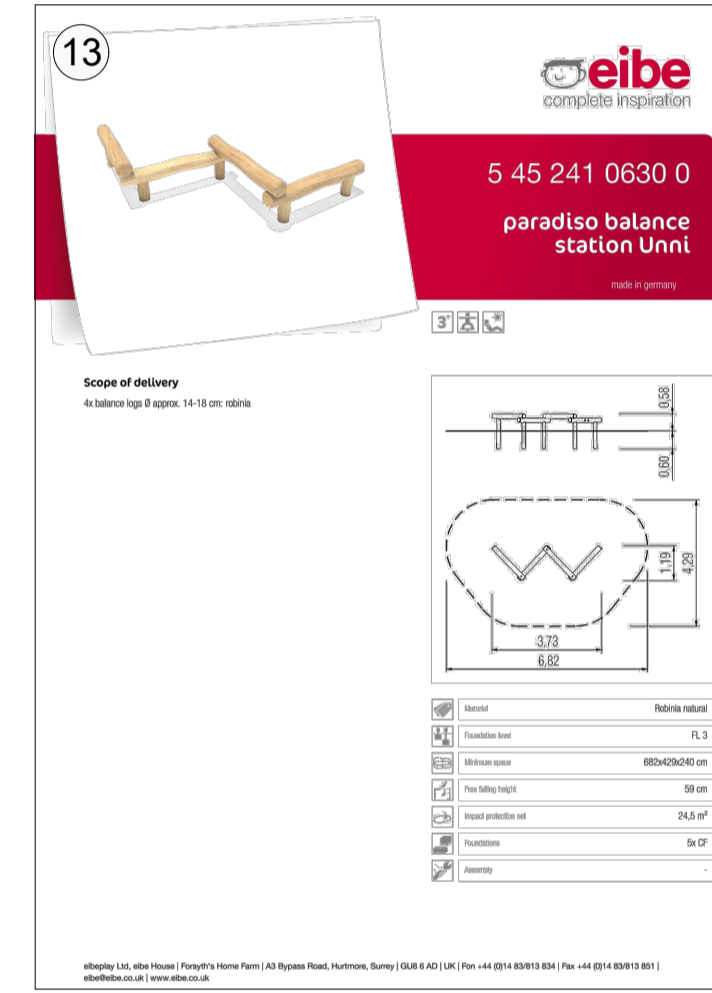

Balance step 40 / 60 Product ref: 55531053115; supplied by Eibe play or similar and approved.



Basics add-on-slide wide GFRP ph 195cm Product ref: 54010510126; supplied by Eibe play or similar and approved.

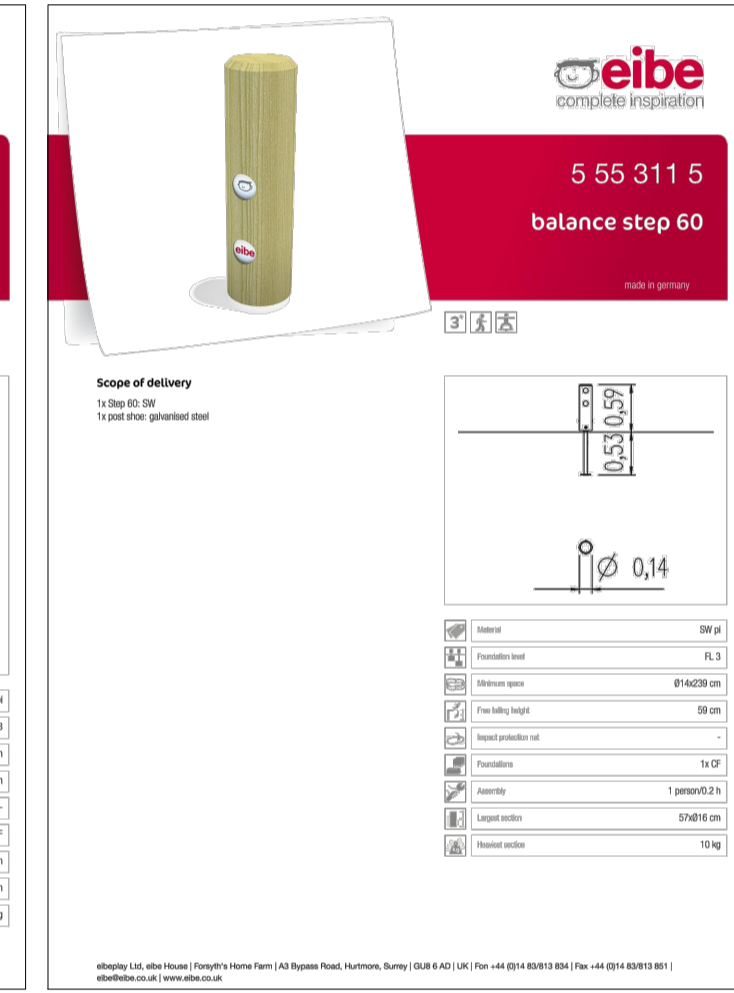

Paradiso Mountaineering ramp Harvis, Product ref: 52504307100; supplied by Eibe play or similar and approved.

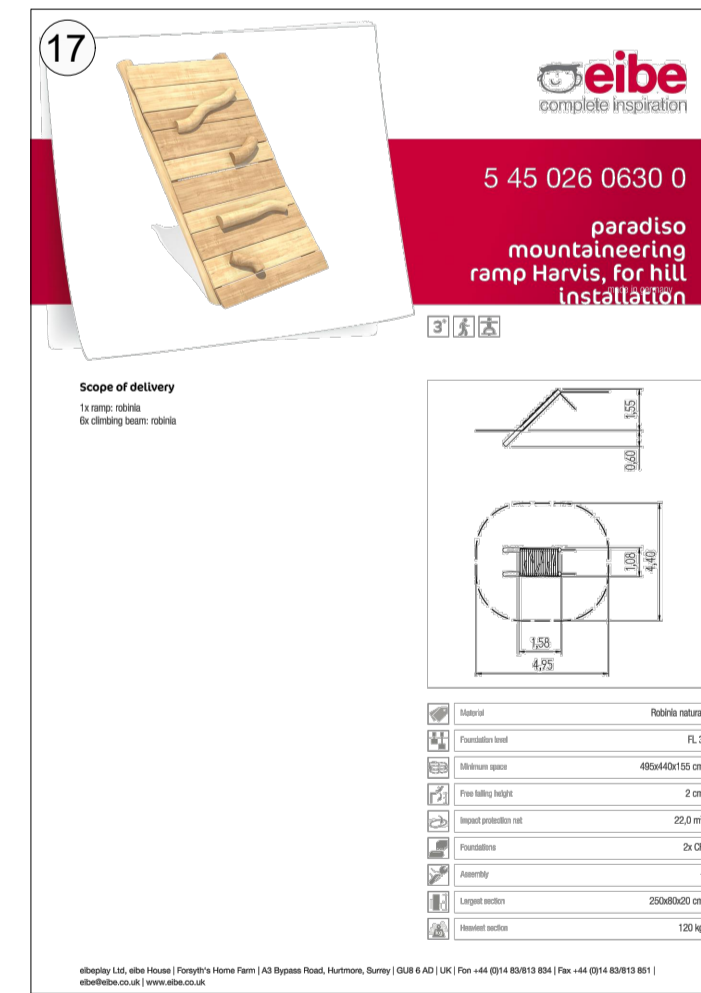

Active trail combination 04, Product ref: 52504007100; supplied by Eibe play or similar and approved.

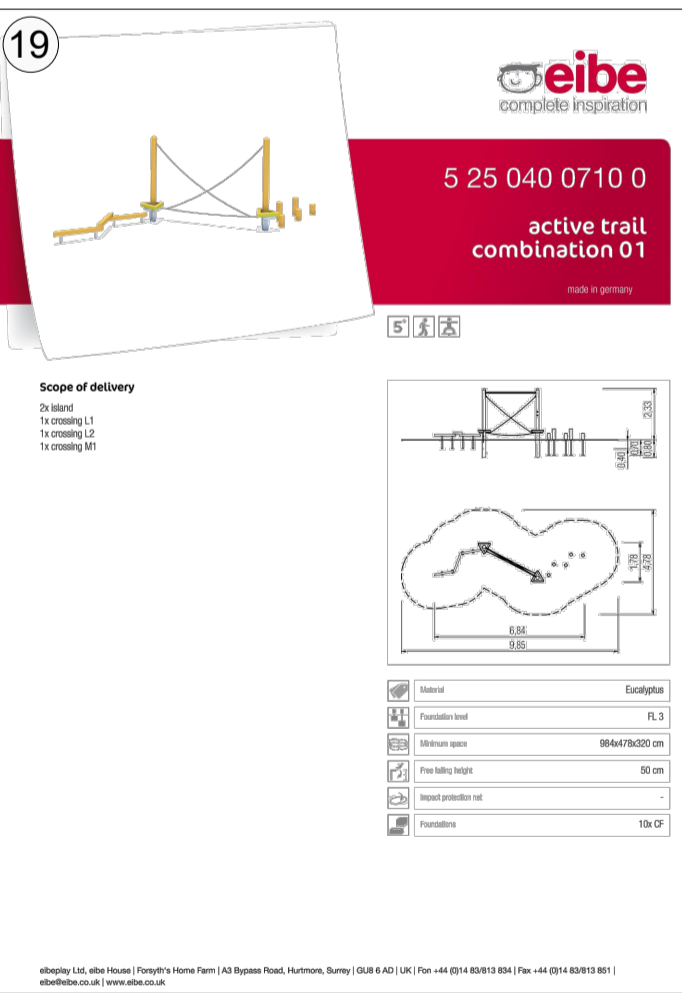

Unique Play Unit Titanos, Product ref: 5250603100 supplied by Eibe play or similar and approved.

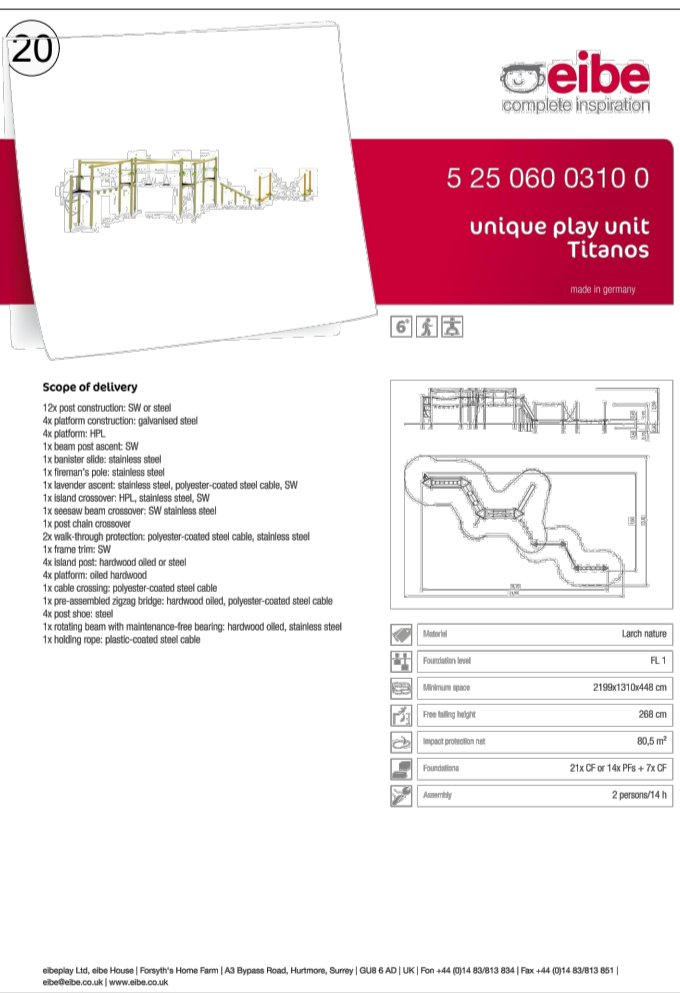

Detail 01 Litter bin, or similar and approved For use in Play areas only



Detail 2 Bench, or similar and approved For use in play areas only



Detail 03 Example Play Equipment

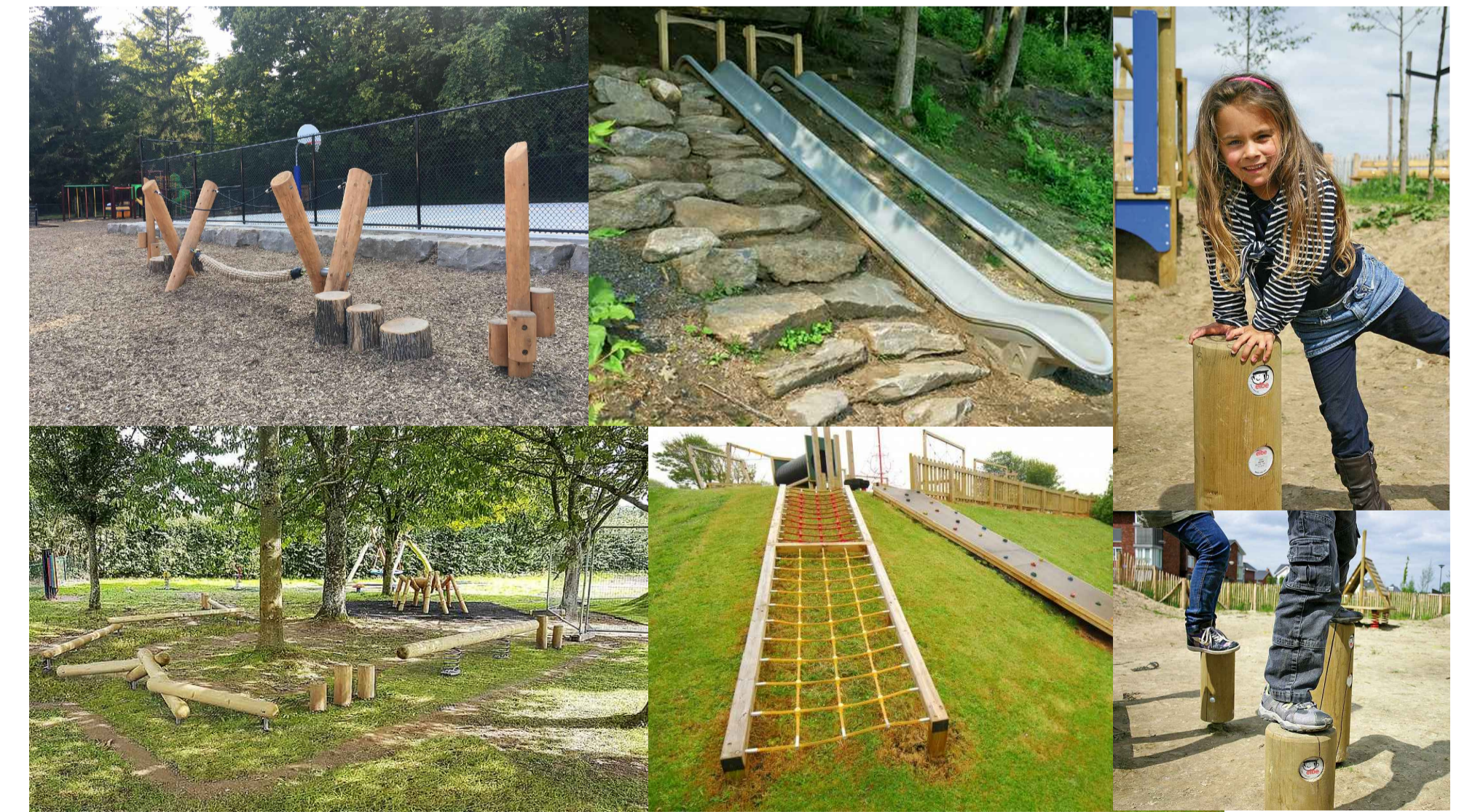

Rev.	Date	Note
00	0000-00-00	00

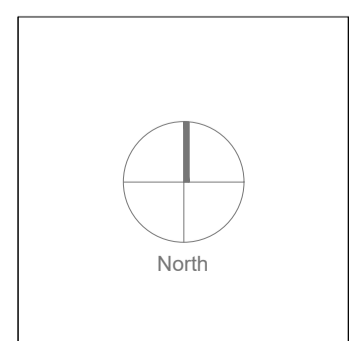

General Notes

Project Name		Oltown Phase 5		Drawing Name		Play Equipment Details	
Status	Planning	Drawing No	PG-02-PP	Revision No	00		
Project No	16-015	Scale	nts	Drawn By	A.D.		
Date	22.03.2022	Checked By	DOT				
Linda Doyle Director +353 (0)1 267 4196 linda@doyle-otroigh.com	Dalith O'Troigh Director +353 (0)1 267 300 3499 dalith@doyle-otroigh.com	Office Address Penrose House 25-27 Upper Pembroke St Dublin 2	Contact mail@doyle-otroigh.com +353 (0)1 608 7722				